

描述 / Descriptions

SOT-23塑封封装肖特基二极管。Schottky diodes in a SOT-23 Plastic Package.

特征 / Features

符合 AEC-Q101 标准高可靠性要求，无卤产品。

Qualified to AEC-Q101 Standards for High Reliability, HF Product.

用途 / Applications

正向电压低，反向恢复时间小，满足汽车应用的严格要求。

Low forward and reverse recovery times, Meet the stringent requirements of automotive applications.

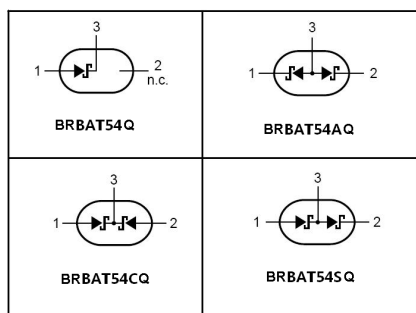
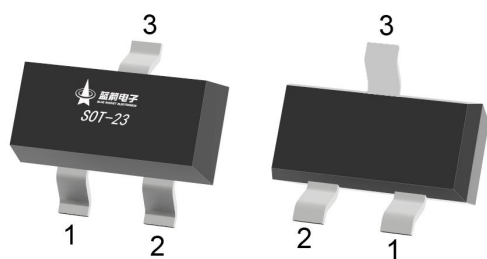
内部等效电路 / Equivalent Circuit**引脚排列 / Pinning**

PIN: See Equivalent Circuit.

印章代码 / Marking

Model	BRBAT54Q	BRBAT54AQ	BRBAT54CQ	BRBAT54SQ
Marking	QL4P	QL42	QL43	QL44

极限参数 / Absolute Maximum Ratings(Ta=25°C)

参数 Parameter	符号 Symbol	数值 Rating	单位 Unit
Repetitive Reverse Voltage	V_{RRM}	30	V
Average Rectified Forward Current	$I_{F(AV)}$	200	mA
Non-repetitive Peak Forward Surge Current	I_{FSM}	600	mA
Power Dissipation	P_D	290	mW
Thermal Resistance, Junction to Ambient	$R_{\theta JA}$	430	°C/W
Junction Temperature	T_J	-40~150	°C
Storage Temperature Range	T_{stg}	-55~150	°C

电性能参数 / Electrical Characteristics(Ta=25°C)

参数 Parameter	符号 Symbol	测试条件 Test Conditions	最小值 Min	典型值 Typ	最大值 Max	单位 Unit
Breakdown Voltage	V_R	$I_R=10\mu A$	30			V
Forward Voltage	V_F	$I_F=0.1mA$			240	mV
		$I_F=1.0mA$			320	mV
		$I_F=10mA$			400	mV
		$I_F=30mA$			500	mV
		$I_F=100mA$			0.8	V
Instantaneous Reverse Current	I_R	$V_R=25V$			2.0	μA
Total Capacitance	C_T	$V_R=1.0V$ $f=1.0MHz$			10	pF
Reverse Recovery Time	t_{rr}	$I_F=I_R=10mA$ $I_{RR}=1.0mA$ $R_L=100\Omega$			5.0	ns

电参数曲线图 / Electrical Characteristic Curve

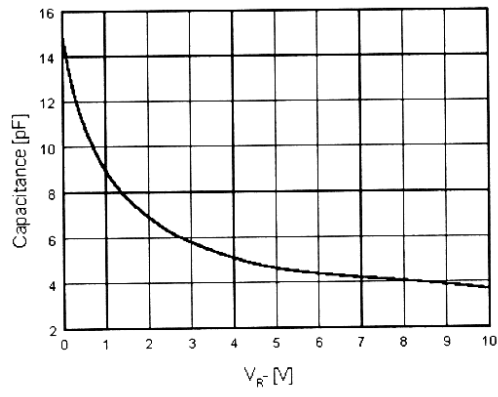
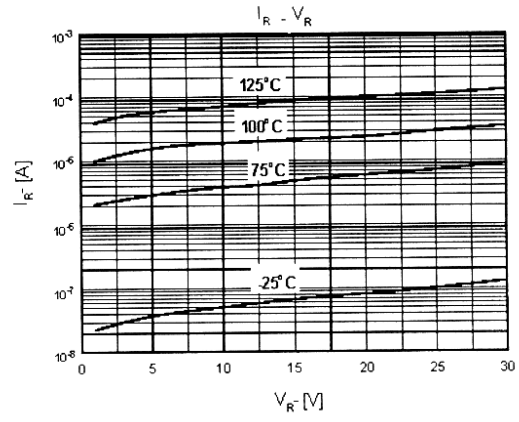
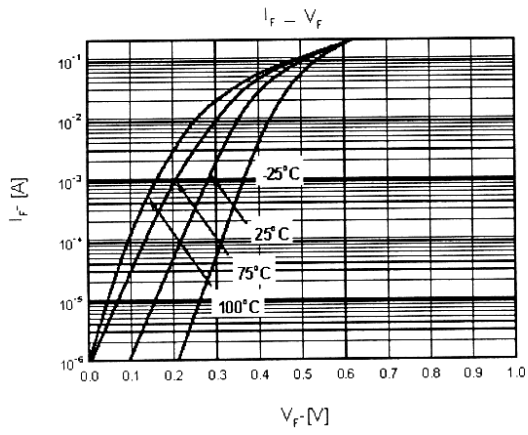

外形尺寸图 / Package Dimensions

SOT-23

单位: mm

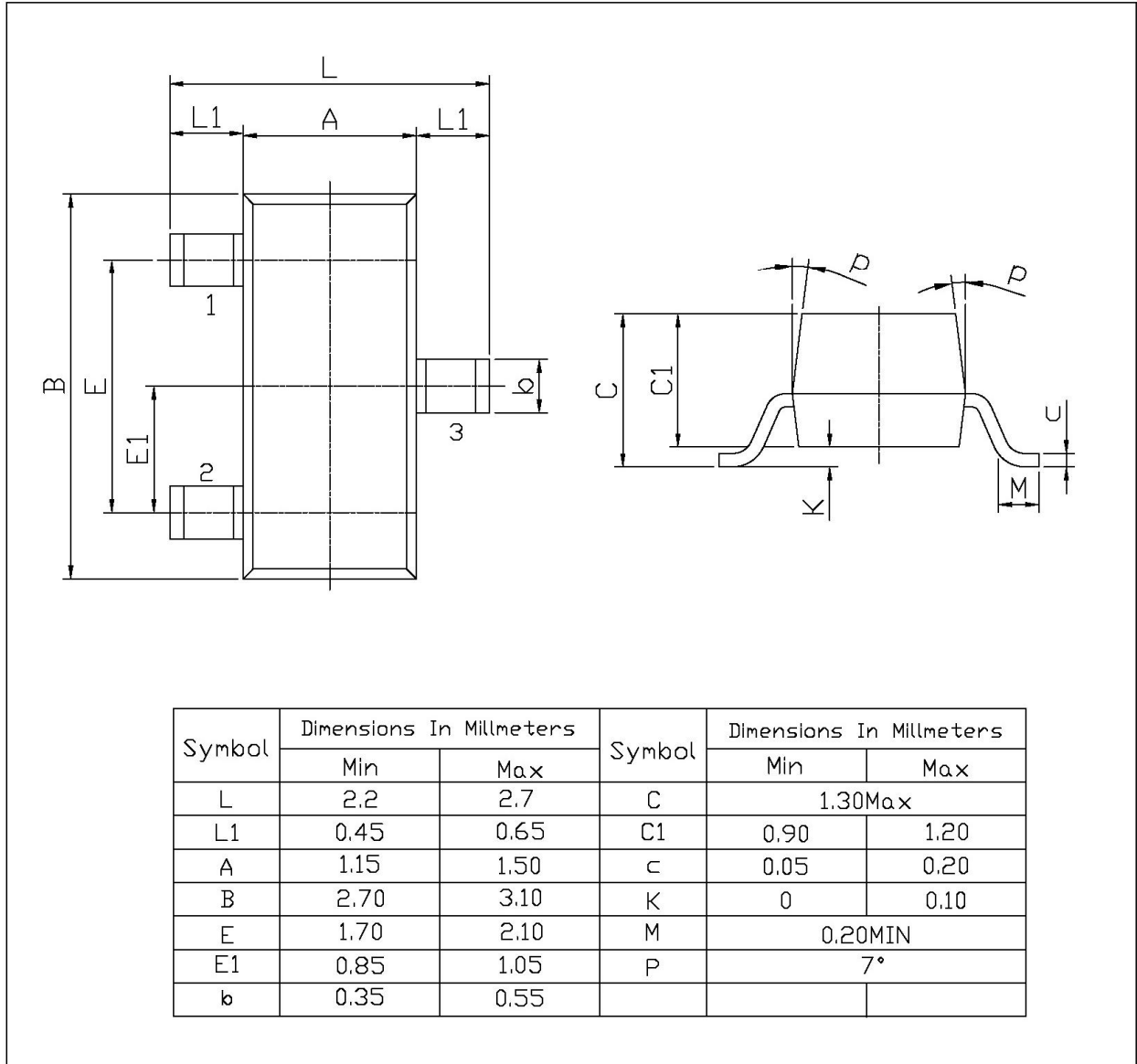

印章说明 / Marking Instructions

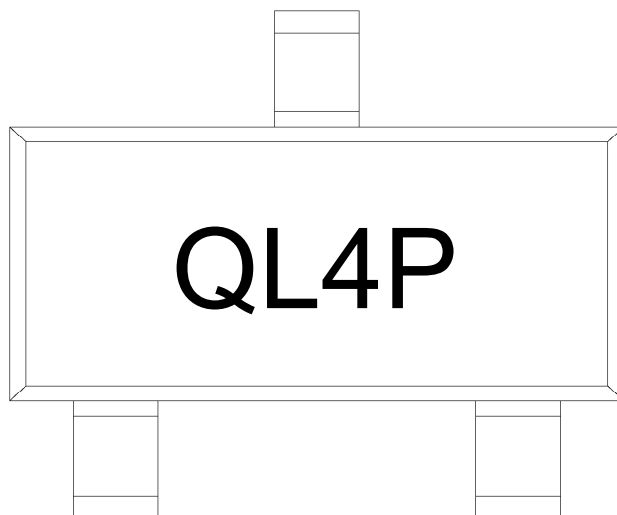

说明：

Q： 为汽车无卤产品标识

L4P： 为型号代码

Note:

Q: Automobile halogen-free product Code

L4P: Product Type Code

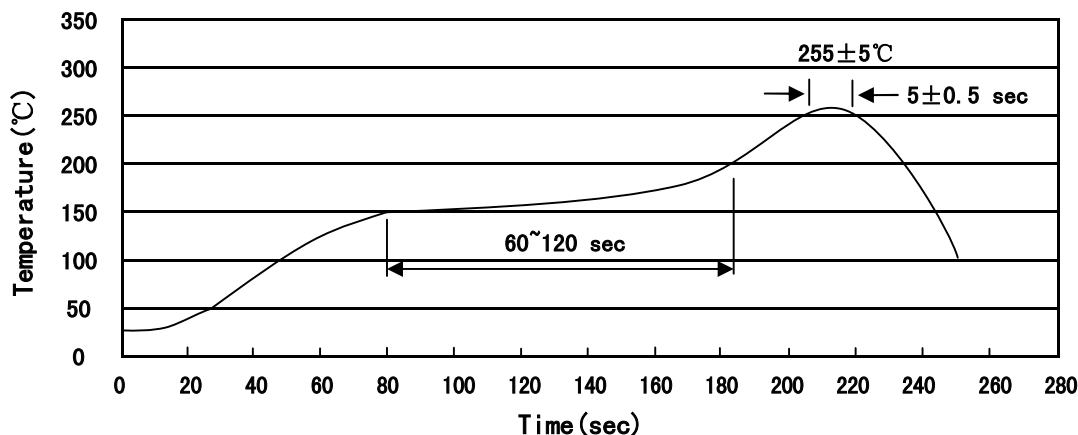
回流焊温度曲线图(无铅) / Temperature Profile for IR Reflow Soldering(Pb-Free)

说明：

- 1、预热温度 150 ~ 200°C，时间 60 ~ 120sec;
- 2、峰值温度 255±5°C，时间持续为 5±0.5sec;
- 3、焊接制程冷却速度为 2 ~ 10°C/sec.

Note:

- 1.Preheating:150~200°C, Time:60~120sec.
- 2.Peak Temp.:255±5°C, Duration:5±0.5sec.
3. Cooling Speed: 2~10°C/sec.

耐焊接热试验条件 / Resistance to Soldering Heat Test Conditions

温度：260±5°C

时间：10±1 sec.

Temp.:260±5°C

Time:10±1 sec

包装规格 / Packaging SPEC.

卷盘包装 / REEL

Package Type 封装形式	Units 包装数量					Dimension 包装尺寸 (unit: mm ³)		
	Units/Reel 只/卷盘	Reels/Inner Box 卷盘/盒	Units/Inner Box 只/盒	Inner Boxes/Outer Box 盒/箱	Units/Outer Box 只/箱	Reel	Inner Box 盒	Outer Box 箱
SOT-23	3,000	10	30,000	6	180,000	7" ×8	180×120×180	390×385×205

使用说明 / Notices